

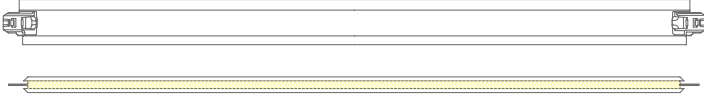

Seamless illumination

## OWAlight | LED profile for S 15b CONSULT

OWAlight 1, profile length 600 mm = 11.4 watts, 600 mm illuminate



OWAlight 2, profile length 1200 mm = 11.4 watts, 600 mm illuminate

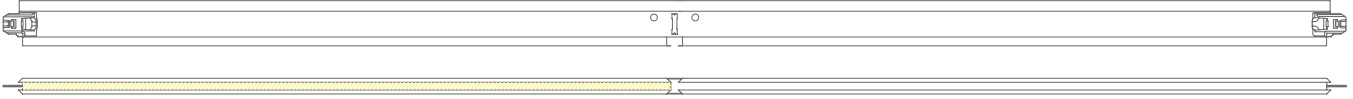

OWAlight 3, profile length 1200 mm = 22.8 watts, 1200 mm illuminate

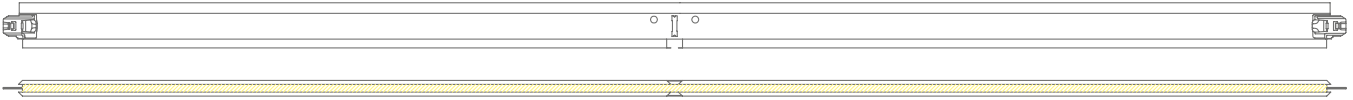

OWAlight 3a, profile length 1200 mm = 22.8 watts, 1200 mm illuminate, no slot in center

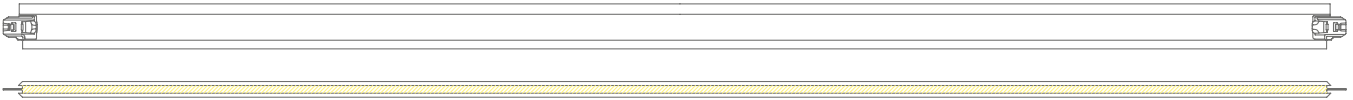

	Name	Dimensions/surface
6	OWAlight 1	LED profile, cross tee, length: 600 mm, height: 41 mm, width: 14.3 mm, white exterior, interior: LED profile illuminated over a length of 600 mm, profiles delivered ready to plug in, cable length 1200 mm
4	OWAlight 2	LED profile, cross tee, length: 1200 mm, height: 41 mm, width: 14.3 mm, white exterior, with central slot, interior: LED profile illuminated over a length of 600 mm, profiles delivered ready to plug in, cable length 1200 mm
4	OWAlight 3	LED profile, cross tee, length: 1200 mm, height: 41 mm, width: 14.3 mm, white exterior, with central slot, interior: LED profile illuminated over a length of 1200 mm, profiles delivered ready to plug in, cable length 1200 mm
4	OWAlight 3a	LED profile, cross tee, length: 1200 mm, height: 41 mm, width: 14.3 mm, white exterior, without central slot, interior: LED profile illuminated over a length of 1200 mm, profiles delivered ready to plug in, cable length 1200 mm
		Transformer for LED profiles with connection for multi-plug, 150 W
		Transformer for LED profiles with connection for multi-plug, 240 W
		Multi-plug with 6 sockets, delivered ready to plug in, connector cable, length: 1500 mm
		Extension cord with plug and socket, length: 2000 mm

The OWAlight LED profiles are installed in the S 15b CONSULT system instead of Cross tees no. 3514CON, no. 3524CON and/or no. 3512CON. This lets you form square light frames in the ceiling grid. You can also install individual LED profiles in parallel or in a staggered patterns. Light rails are delivered ready to plug in and are easily connected via the multi plug to the transformer. On request, OWAconsult® can provide lighting calculations, layout plans, and quantity calculations for OWAlight. Light colour neutral white (4000 K), Output 19 W/m.

**Note:** OWAlight rails can only be combined with the S 15b CONSULT system support and cross tees with order numbers 3500CON, 3512CON, 3514CON and 3524CON. Please always order together with the ceiling construction S 15b CONSULT. When installing OWAlight into an existing S 15b CONSULT ceiling, please first contact OWAconsult® for clarification.

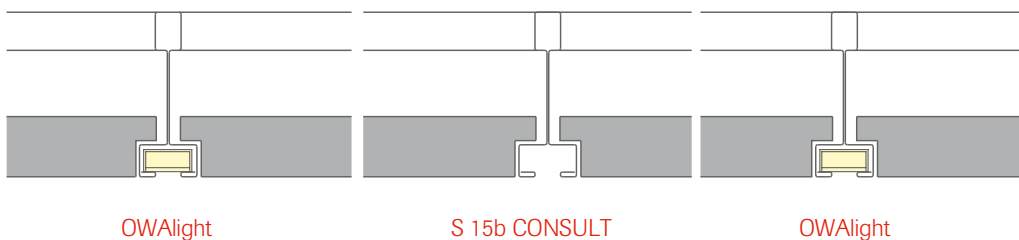

# OWAlight in S 15b CONSULT

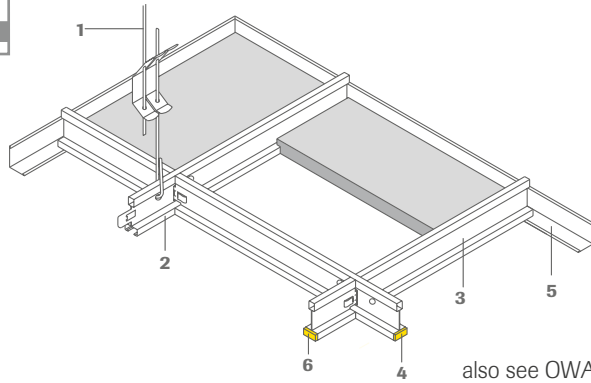

- 1 Hanger no. 12/30/2
- 2 Main tee no. 3500CON
- 3 Cross tee no. 3512CON
- 4 OWAlight 2 or OWAlight 3
- 4 OWAlight 3a
- 5 Wall angle no. 50G
- 5 Wall angle no. 1456 (configuration with full tiles)
- 6 OWAlight 1

also see OWA-brochure no. 1022

## OWAlight | installation examples

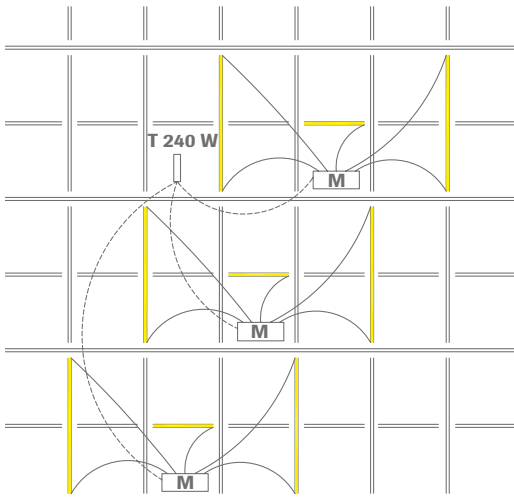

**M** = Multi-plug                    3 pcs  
**T** = Transformer                    1 pce

3 x OWAlight 1 = 11.4 watts = 34.20 watts  
 6 x OWAlight 3 = 22.8 watts = 136.80 watts  
 + 10 % buffer                    = 15.00 watts  

---

 Required power                    186.00 watts

Please use a 240 watts transformer.

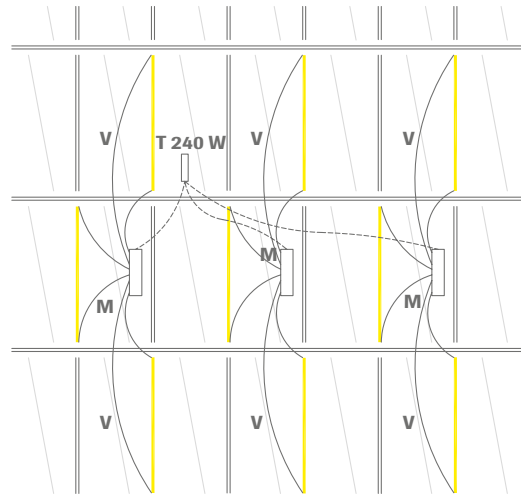

**M** = Multi-plug                    3 pcd  
**T** = Transformer                    1 pce  
**V** = Extension cord,                6 pcs  
    length 2.0 m

9 x OWAlight 3a = 22.8 watts = 205.20 watts  
 + 10 % Reserve                    = 24.00 watts  

---

 Required power                    229.20 watts

Please use a 240 watts transformer.



## System description:

**OWAlight 1**, LED profile, cross tee, length: 600 mm, height: 41 mm, width: 14.3 mm, white exterior, interior: 600 mm illuminate, profiles delivered ready to plug in, cable length 1200 mm, to be connected to a multi-plug.

**OWAlight 2**, LED profile, cross tee, length: 1200 mm, height: 41 mm, width: 14.3 mm, white exterior, interior: 600 mm illuminate, profiles delivered ready to plug in, cable length 1200 mm, to be connected to a multi-plug.

**OWAlight 3**, LED profile, cross tee, length 1200 mm, height: 41 mm, width: 14.3 mm, white exterior, interior: 1200 mm illuminate, profiles delivered ready to plug in, cable length 1200 mm, to be connected to a multi-plug, rail with central slot.

**OWAlight 3a**, LED profile, cross tee, length 1200 mm, height: 41 mm, width: 14.3 mm, white exterior, interior: 1200 mm illuminate, profiles delivered ready to plug in, cable length 1200 mm, to be connected to a multi-plug, rail without central slot (use only with 1200 x 600 mm grid pattern).

**Installation** should be carried out in accordance with the information contained in brochure no. 1011 and OWA-Installation Guide 801. All components are CE labelled.

## Product Warranties

The information provided in this leaflet is based on the standards and data available at the time of publication. Any performance, warranties or guarantees provided, expressed or implied, are subject to the exclusive use of OWA components and the installation of those components in accordance with our recommendations. Failure to adhere to these conditions will result in the invalidation of any performance claims, warranties or guarantees and rejection of any liability. OWA reserves the right to make any technical improvements to the products, systems or services without prior notice. **All goods and services are supplied in accordance with our current Terms and Conditions of Sale.** Errors excepted!



# OWA

**Odenwald Faserplattenwerk GmbH**  
Dr.-F.-A.-Freundt-Straße 3 | 63916 Amorbach  
tel +49 93 73.2 01-0 | info@owa.de  
www.owa-ceilings.com

Brochure **1011 e**  
111400